

Technical Specification

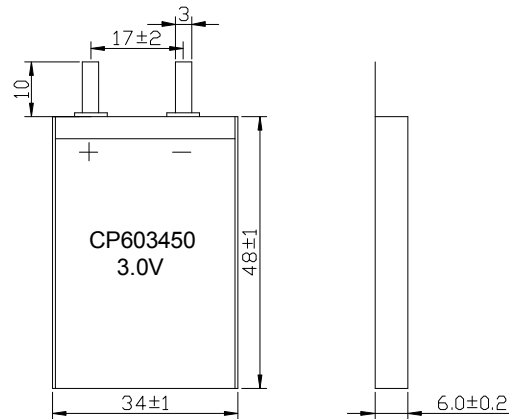

The picture are just for your reference.
Please be subject to the actual products.

1、Application range

Lithium Manganese Dioxide Thin Cell battery, Model CP603450
Manufacturer: Wuhan Haocheng Energy Resources Technology Co.,Ltd.

2、Objective

To regulate the performance index and test method of CP603450, as well as guidelines and warnings.

3、Technical parameter

- 3.1 Model: CP603450
- 3.2 Nominal voltage: 3.0V
- 3.3 Nominal capacity: 2300mAh(Continuously discharged under 5mA current till 2.0V end-voltage at the temperature of 23°C±3°C)
- 3.4 Max. constant current: 1200mA
- 3.5 Max. pulse current: 1500mA
- 3.6 Operating temperature range: -40°C~+60°C
- 3.7 Nominal weight: 18g.
- 3.8 Max. Outer dimensions: as drawing.
- 3.9 Structures: Manganese dioxide cathode 、 lithium anode 、 organic electrolyte 、 polypropylene、 separator and steel battery can and cap.
- 3.10 Self-discharging rate: ≤2% per year.

4、Discharge performance

4.1 Constant-current discharge

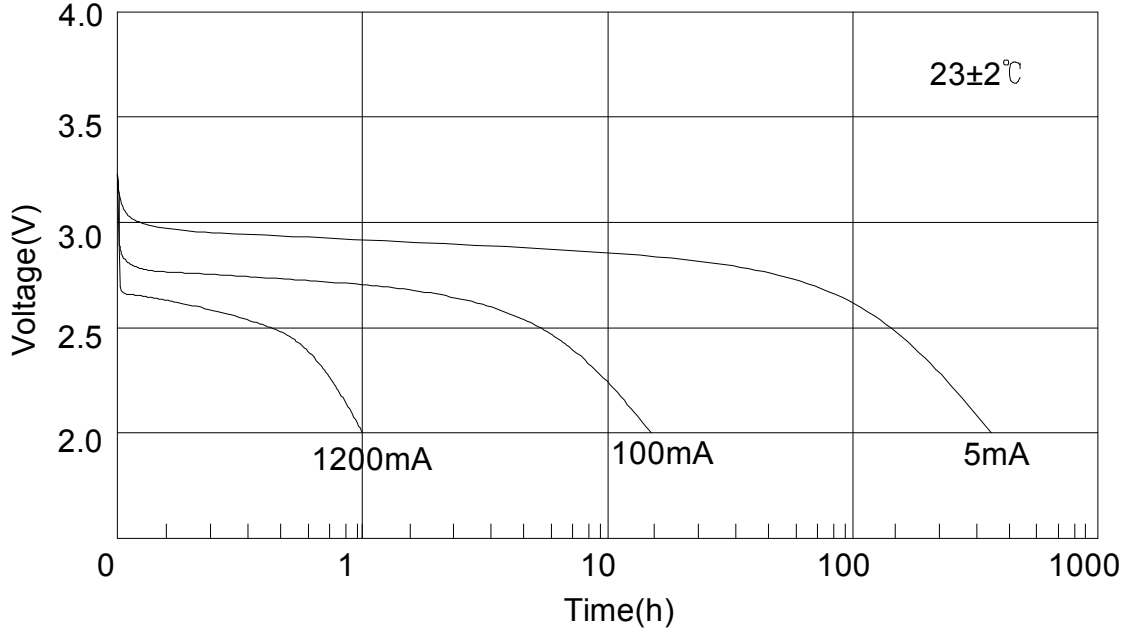

4.2 Constant resistance discharge at different temperatures

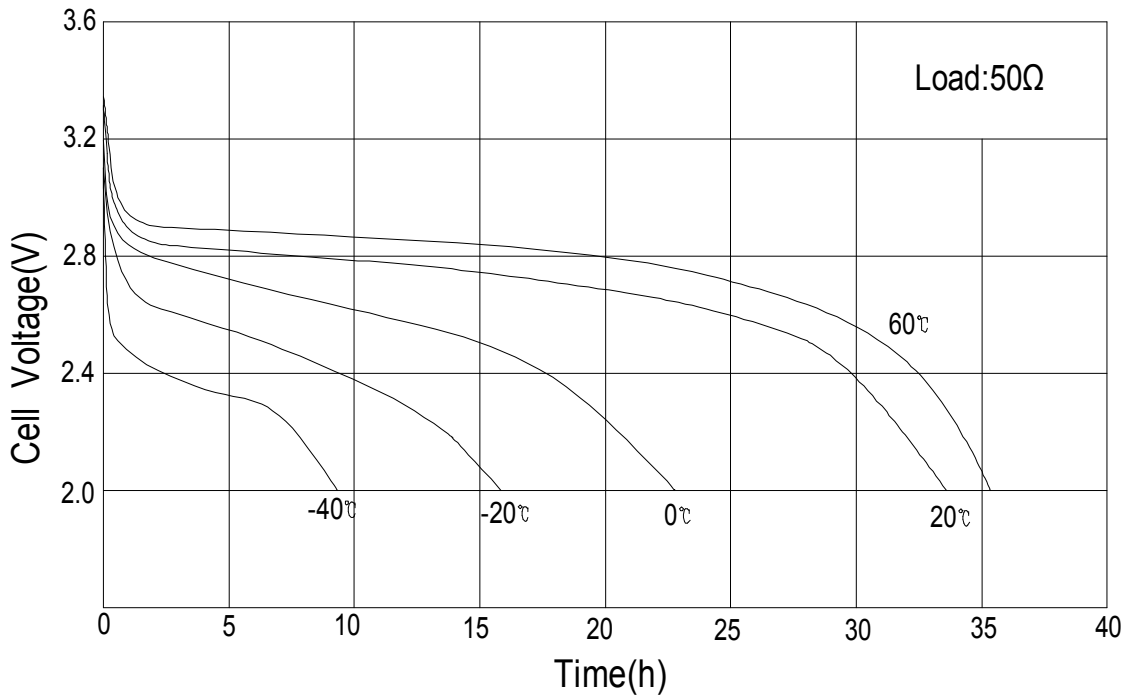

5、Certification



ISO-16628



**EU 02
031073 01**



MH10060

RoHS

No.03007